

P350 flexitrac™ system

Technical specification

90/P350-TECH-SPEC/08



P350 flexitrac technical specification

Controllers	P350 Standard Controller	P350+ Controller with on-board pushrod battery
Screen	8" (200mm) Industrial TFT, SVGA resolution	
Controls	Analog joysticks, bespoke keypad, full-sized keyboard for report writing	
Connectivity	USB 2.0, Analog video in/out (PAL/NTSC), Analog audio in/out, Ethernet, Bluetooth®	
Data storage media	USB memory stick, Compact Flash (CF) card (see Operation Manual for details)	
Recording time (based on 8Gb CF card)	7 hours (at highest quality), 15 hours (mid quality), 36 hours (standard quality)	
Reporting standards supported	MSCC3, PACP	
Data output format	H.264, AAC, MP4, JPEG	
Construction	ABS, steel, Aluminum	
Dimensions	360 x 360 x 200mm / 14 x 14 x 8"	
Ingress protection	IP55 (closed), IP53 (open)	
Temperature rating	-20 to 80°C / -4 to 176°F (storage), -10 to 50°C / 14 to 122°F (operating)	
Weight	5.5kg / 12lb	6.2kg / 13.5lbs
Battery capacity	–	98Wh, 14 hours view (typ) / 7 hours recording (typ)

Pendant controller	For use in crawler deployment
Controls	Crawler, drum, camera, sonde
Construction	Linear Medium Density Polyethylene (LMDPE) and mild steel
Ingress protection	IP64
Weight	0.7kg / 1.5lbs
Dimensions	250 x 80 x 40mm / 9.8 x 3.1 x 1.6"

Drums and PSU	Powered drum	Manual drum system	
		Manual drum	Power supply
Cable lengths available	100m, 150m, 200m, 250m, 305m / 330', 495', 660', 820', 1000'	–	
Connectivity	Direct pushrod connection, power, controller and pendant	Power supply	Direct pushrod connection, power, controller and pendant
Power supply	110-240V 50-60Hz 1.2kVA Inverter or generator to have sine-wave output	P350 Power supply	110-240V 50-60Hz 1.2kVA Inverter or generator to have sine-wave output
Construction	Powder coated steel chassis / frame with steel and Aluminum enclosure Stainless steel and Aluminum cable management mechanism	Powder coated steel chassis / frame with steel and Aluminum enclosure	
Dimensions	619 x 405 x 691mm 24.4 x 16 x 27"	445 x 270 x 570mm 17.5 x 10.6 x 22.4"	418 x 195 x 420mm 16.5 x 7.7 x 16.5"
Ingress protection	IP53		
Weight (dependent on cable length)	60 to 75kg / 130 to 154lbs	20 to 35kg / 44 to 77lbs	17kg / 37.5lbs

Crawlers	P354 small crawler	P356 medium crawler
Centred pipe inspection diameter range (with appropriate accessories)	100 – 381mm / 4 – 15"	150 – 900mm / 6 – 36"
Construction	Brass and Stainless Steel	
Ingress protection	IP68	
Ingress sealing	Rated to a depth of 100m / 330' of water	
Sonde frequency	Selectable 512Hz / 640Hz / 8kHz / 33kHz	
Sonde detection depth	Up to 3m	
Inclinometer accuracy	±0.2°	
Steering	Fixed	Steerable
Motor(s)	1 x 50W GP32C Maxon motor	2 x 50W GP32C Maxon motor
Weight	5.4kg / 12lbs	14.3kg / 31.5lbs
Dimensions (without wheels attached)	250 x 82 x 69mm / 9.8 x 3.2 x 2.7"	345 x 128 x 84mm / 13.6 x 5 x 3.3"

Elevators	Fixed elevator	Adjustable elevator	Large manual elevator	Powered elevator
Centred pipe inspection diameter – P354 crawler	305mm/ 12"	230 – 380mm/9– 15"	–	–
Centred pipe inspection diameter – P356 crawler	380mm/ 15"	305mm – 458mm/12–18"	305mm – 610mm/12–24"	305mm – 900mm/12–36"
Construction	Stainless steel/Anodized Aluminum	Stainless steel	Stainless steel/Anodized Aluminum	Stainless steel/Anodized Aluminum
Weight	0.4kg/0.9lbs	0.7kg/ 1.5lbs	4.5kg/9.9lbs	5.8kg/ 12.8lbs
Dimensions @ maximum elevation	114 x 48 x 67 mm 2.5 x 1.9 x 2.9"	150 x 50 x 70 mm 6 x 2 x 2.8"	230 x 90 x 420mm 9 x 3.6 x 16.5"	380 x 110 x 420mm 15 x 4.3 x 16.5"

Lighthouse	Provides additional light for large or dark pipes
Lighting	8 White LEDs, ≥ 850 Lumen
Construction	Stainless Steel and Aluminum
Ingress protection	IP68
Ingress sealing	Rated to a depth of 100m/330' of water
Weight	1.8kg/4.0lbs
Dimensions	63 x 136 x 136mm/2.5 x 5.4 x 5.4"

Cameras	Forward-view	Pan-Tilt	Pan-Tilt-Zoom
Functions	Forward view only	Pan 270° / Rotate 360°	Pan 270° / Rotate 360°
Zoom	3x digital	3x digital	10x optical
Resolution	≥540TVL	≥540TVL	≥530TVL
Sensitivity	< 1.0Lux	< 1.0Lux	1.0Lux @ f1.8
On-camera lighting	≥120lm	≥210lm	≥420lm
Focal Range	10mm to ∞		10mm (WIDE) to ∞
Construction	Stainless Steel	Stainless Steel and Anodized Aluminum	Stainless Steel and Anodized Aluminum
Dimensions	62 x 68mm/2.4 x 2.7"	134 x 68mm/5.3 x 2.7"	158 x 90mm/6.2 x 3.5"
Weight	600g/ 1.3lbs	1.8kg/4.0lbs	2.9kg/ 6.4lbs*

*Note, check for compatibility when using Pan-Tilt-Zoom camera with P354 crawler

Crawler wheels and spacers	Types available	
Solid wheels	Choice of: Soft compound (high grip) or Hard compound (more durable) tires	
	Small: 62mm/2½" Ø P354: for 100mm/4" pipes P356: for 150mm/6" pipes	Medium: 110mm/4¼" Ø P354: for 150mm/6" pipes P356: for 200mm/8" pipes
Pneumatic wheels	177mm/7" treaded tyres for use in larger pipes P356: for pipes larger than 375mm/15" Ø	
Dual pneumatic wheels	Stack pneumatic tires 2-wide for additional grip or to raise camera position	
Rasp wheels	Abrasive style wheels provide additional traction in slippery or relined pipes	
	Small	Medium
Wheel spacers	To space wheels out, providing centering in specific pipe sizes	
For Rasp wheels	Small, with spacers: P354: for 150mm/6" pipes	Medium, with spacers: P354: for 200mm/8" pipes P354: for 230mm/9" pipes P356: for 200mm/8" pipes P356: for 230mm/9" pipes
For medium wheels	P356: for 230mm/9" pipes	

Link cables	To connect P350 system modules together, lengths available:
Controller to PSU/Powered drum	1m/3' 5m/16' 10m/32' 15m/49' 20m/65' 25m/82' 50m/164'
PSU to manual drum	1m/3' 3m/10' 10m/32' 20m/65' 50m/164'
Controller to P340 flexiprobe® pushrod	5m/16' 10m/32' 15m/49' 20m/65' 30m/98'

Approvals	
CE	LVD 2006/95/EC, MD 2006/42/EC, EMC 2004/108/EC, RTTE 99/5/EC
FCC	CFR47 Part 15B
Standards	EN 61010-1:2010, IEC61010-1:2010
RoHS	Compliant

Crawler-Wheel-Elevator Configurations

Note: Larger and double stack wheels should be used where possible for maximum stability.

Standard wheels	P354 options		P356 options	
	Wheels	Elevator	Wheels	Elevator
100mm/4"	Small standard	None	n/a	n/a
152mm/6"	Medium standard	None	Small standard	None
203mm/8"	Double-stacked medium standard	None	Medium standard	None
254mm/10"	Medium standard	Fixed	Double-stacked medium standard	None
	Medium standard	Adjustable		
305mm/12"	Double-stacked medium standard	Fixed	Medium standard	Fixed
	Double-stacked medium standard	Adjustable	Medium standard	Adjustable
			Medium standard	Large adjustable
381mm/15"	Double-stacked medium wheels	Adjustable	Medium standard	Large adjustable
			Large standard	Fixed
			Large standard	Adjustable
457mm/18"	n/a	n/a	Large standard	Adjustable
			Large standard	Large adjustable
			Double-stacked large standard	Adjustable
			Double-stacked large standard	Large adjustable
533mm/21"	n/a	n/a	Large standard	Large adjustable
			Double-stacked large standard	Large adjustable
610mm/24"	n/a	n/a	Large standard	Large adjustable
			Double-stacked large standard	Large adjustable
305-762mm/12-30"	n/a	n/a	Medium standard	Powered
381-864mm/15-34"	n/a	n/a	Large standard	Powered
457-915mm/18-36"	n/a	n/a	Double-stacked large standard	Powered

Grit wheels	P354 options – no elevator required		P356 options – no elevator required	
	Wheels	Wheel adaptor	Wheels	Wheel adaptor
152mm/6"	Small grit	3-groove	n/a	n/a
203mm/8"	Large grit	4-groove	Large grit	1-groove
229mm/9"	Large grit	5-groove	Large grit	2-groove

Crawler configuration examples

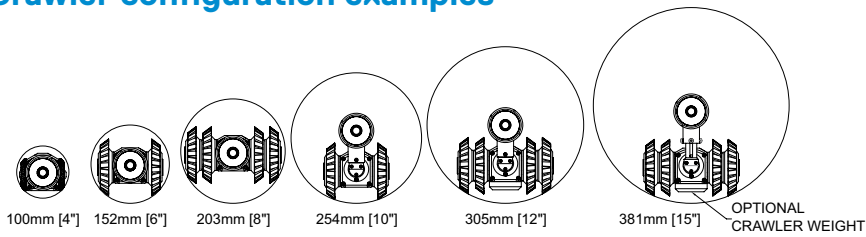

P354 CRAWLER (ADJUSTABLE ELEVATOR) CONFIGURATIONS
(100mm [4"] - 381mm [15"] PIPE)

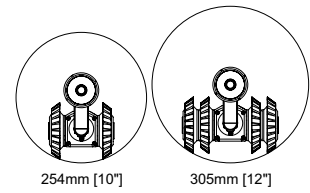

P354 CRAWLER (FIXED ELEVATOR) CONFIGURATIONS
(254mm [10"] - 305 [12"] PIPE)

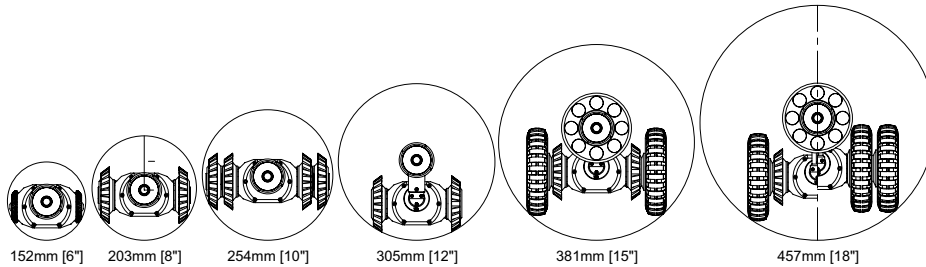

P356 CRAWLER (ADJUSTABLE ELEVATOR) CONFIGURATIONS
(152mm [6"] - 457mm [18"] PIPE)

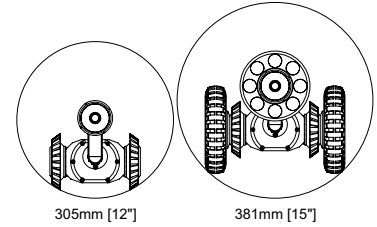

P356 CRAWLER (FIXED ELEVATOR) CONFIGURATIONS
(305mm [12"] - 381mm [15"] PIPE)

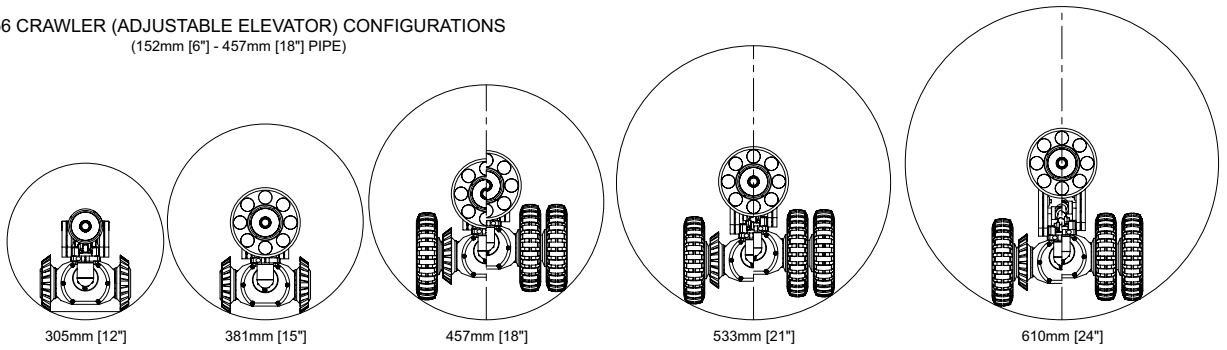
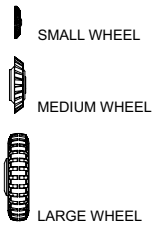

P356 CRAWLER (LARGE ADJUSTABLE ELEVATOR) CONFIGURATIONS
(305mm [12"] - 610mm [24"] PIPE)

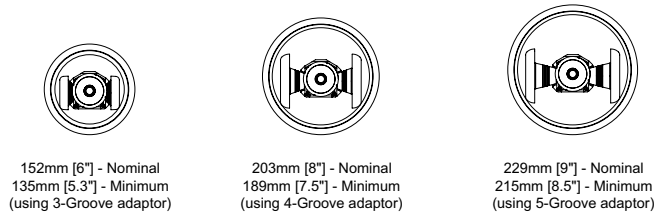
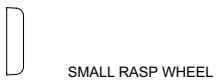

P354 CRAWLER RASP WHEEL CONFIGURATIONS
(152mm [6"] - 229mm [9"] PIPE)

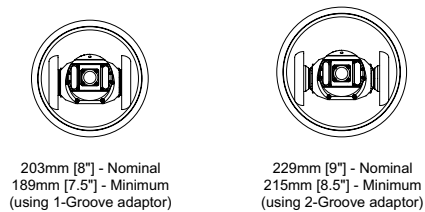

P356 CRAWLER RASP WHEEL CONFIGURATIONS
(203mm [8"] - 229mm [9"] PIPE)

Visit www.pearpoint.com

Global locations

Pearpoint (USA)

39-740 Garand Lane, Unit B, Palm Desert, CA 92211, USA

Tel: +1 800 688 8094 Tel: +1 760 343 7350 pearpoint.sales.us@spx.com

Radiodetection (USA)

28 Tower Road, Raymond, Maine 04071, USA

Tel: +1 (207) 655 8525 Toll Free: +1 (877) 247 3797 rd.sales.us@spx.com

Radiodetection (Canada)

344 Edgeley Boulevard, Unit 34, Concord, Ontario L4K 4B7, Canada

Tel: +1 (905) 660 9995 Toll Free: +1 (800) 665 7953 rd.sales.ca@spx.com

Radiodetection Ltd. (UK)

Western Drive, Bristol, BS14 0AF, UK

Tel: +44 (0) 117 976 7776 rd.sales.uk@spx.com

Radiodetection (France)

13 Grande Rue, 76220, Neuf Marché, France

Tel: +33 (0) 2 32 89 93 60 rd.sales.fr@spx.com

Radiodetection (Benelux)

Industriestraat 11, 7041 GD 's-Heerenberg, Netherlands

Tel: +31 (0) 314 66 47 00 rd.sales.nl@spx.com

Radiodetection (Germany)

Groendahlscher Weg 118, 46446 Emmerich am Rhein, Germany

Tel: +49 (0) 28 51 92 37 20 rd.sales.de@spx.com

Radiodetection (Asia-Pacific)

Room 708, CC Wu Building, 302-308 Hennessy Road, Wan Chai, Hong Kong SAR, China

Tel: +852 2110 8160 rd.sales.asiapacific@spx.com

Radiodetection (China)

13 Fuqianyi Street, Minghao Building D304, Tianzhu Town, Shunyi District, Beijing 101312, China

Tel: +86 (0) 10 8146 3372 rd.service.cn@spx.com

Radiodetection (Australia)

Unit H1, 101 Rookwood Road, Yagoona NSW 2199, Australia

Tel: +61 (0) 2 9707 3222 rd.sales.au@spx.com